

# Specification for Approval

Customer: \_\_\_\_\_

Model Name: AM-200200-015A

Supplier Approval			Customer approval
R&D Designed	R&D Approved	QC Approved	
Sam	Peng Jun		



Revise Records

Rev.	Date	Contents	Written	Approved
A	2024-04-02	Preliminary Specification	sam	Peng Jun

Special Notes

Note1.	

## Contents

<b>1</b>	<b>General Description and Features</b> .....	<b>4</b>
1.1	Features	4
1.2	LCD Module	4
<b>2</b>	<b>Mechanical Information</b> .....	<b>4</b>
<b>3</b>	<b>Absolute Max. Ratings</b> .....	<b>5</b>
3.1	Absolute Ratings of Environment	5
3.2	Electrical Absolute Rating	5
<b>4</b>	<b>Electrical Characteristics</b> .....	<b>6</b>
4.1	TFT-LCD Module	6
<b>5</b>	<b>Input Terminal Pin Assignment</b> .....	<b>7</b>
5.1	CN1 Pin Assignment	7
<b>6</b>	<b>Optical Characteristics</b> .....	<b>8</b>
<b>7</b>	<b>AC Characteristics</b> .....	<b>11</b>
7.1	Interface Timing	11
7.2	Power ON/OFF sequence	12
<b>8</b>	<b>Test</b> .....	<b>13</b>
<b>9</b>	<b>Dimensional outlines</b> .....	<b>14</b>
<b>10</b>	<b>Incoming Inspection Standards</b> .....	<b>15</b>

## 1 General Description and Features

AM-122250-021A is a mono active matrix thin film transistor (TFT) liquid crystal display (LCD) that uses amorphous silicon TFT as a switching device. It is a reflective type display operating in the total reflection. This TFT LCD has a 1.54 inch diagonally measured active display area with 200 horizontal by 200 vertical pixel resolution.

### 1.1 Features

- 1.54 inch configuration
- Mono by 2 Grey signal input
- ROHS Compliance & Halogen Free

### 1.2 LCD Module

Item	Specification	Unit
Screen Size	1.54 inches	Diagonal
Display Resolution	200(H) x RGB x 200(V)	Dot
Pixel Pitch	0.1383(H) x 0.1383(V)	mm
Active Area	27.66 (H) x 27.66(V)	mm
Outline Dimension	29.46(W) x 31.71 (H) x0.72 (D)	mm
Display Mode	Normally white	--
Surface Treatment	Anti-glare (AG05)	--
Viewing Direction	All	--
Driver IC	ST7306	

## 2 Mechanical Information

Item		Min.	Typ.	Max.	Unit	Note
Module Size	Horizontal (H)	29.36	29.46	29.56	mm	--
	Vertical (V)	31.61	31.71	31.81	mm	(1)
	Thickness (T)	0.71	0.72	0.73	mm	(1)

Note (1) Not include FPC.

Refer to the Dimensional Outlines for further information.

### 3 Absolute Max. Ratings

#### 3.1 Absolute Ratings of Environment

If the operating condition exceeds the following absolute maximum ratings, the TFT LCD module may be damaged permanently.

( $T_a=25\pm 2^{\circ}\text{C}$ ,  $V_{SS}=\text{GND}=0$ )

Item	Symbol	Min.	Max.	Unit	Note
Storage temperature	$T_{STG}$	-30	80	$^{\circ}\text{C}$	(1)
Operating temperature	$T_{OPR}$	-20	70	$^{\circ}\text{C}$	(1,2,3)

Note (1) 95 % RH Max. ( $40^{\circ}\text{C} \geq T_a$ ). Maximum wet-bulb temperature at  $39^{\circ}\text{C}$  or less. ( $T_a > 40^{\circ}\text{C}$ )  
No condensation.

Note (2) In case of below  $0^{\circ}$ , the response time of liquid crystal (LC) becomes slower and the color of panel becomes darker than normal one. Level of retardation depends on temperature, because of LC's character

Note (3) Only operation is guaranteed at operating temperature. Contrast, response time, another display quality are evaluated at  $+25^{\circ}\text{C}$ .

#### 3.2 Electrical Absolute Rating

( $T_a=25\pm 2^{\circ}\text{C}$ ,  $V_{SS}=\text{GND}=0$ )

Item	Symbol	Value		Unit	Condition
		Min.	Max.		
I/O Power Supply Voltage	VDDI	-0.3	+4	V	
Analog Power Supply Voltage	VDDA	-0.3	+4	V	
Reference Power Supply Voltage	VDDR	-0.3	+4	V	
LCD Driver Supply Voltage	AVDD	-0.3	+6.4	V	
	VSH-VSL	-0.3	+6.2	V	
	VGH-VGL	-0.3	+33	V	
Logic Input Voltage Range	VIN	-0.3	VDDI+0.5	V	
Logic Output Voltage Range	VO	-0.3	VDDI+0.5	V	

## 4 Electrical Characteristics

### 4.1 TFT-LCD Module

Parameter	Symbol	Condition	Specification			Unit	Related Pins
			MIN.	TYP.	MAX.		
Power & Operation Voltage							
Analog Power Supply (Normal Mode)	VDDA\VDDR	Analog Power	2.55		3.6	V	
Digital Power Supply (Normal Mode)	VDDI	I/O Supply Voltage	1.65		3.6	V	
Power Supply (1.8V Mode)	VDDA\VDDR VDDI	Single Power	1.7	1.8	1.9	V	
Gate Driver High Voltage	VGH		8.0		16.5	V	Note 1
Gate Driver Low Voltage	VGL		-15.0		-6.0	V	
Gate Driver Supply Voltage		VGH-VGL	14.0		31.5	V	Note 2
Input / Output							
Logic-High Input Voltage	VIH		0.7VDDI		VDDI	V	
Logic-Low Input Voltage	VIL		VSS		0.3VDDI	V	
Logic-High Output Voltage	VOH	IOH = - 1.0mA	0.8VDDI		VDDI	V	
Logic-Low Output Voltage	VOL	IOL = +1.0mA	VSS		0.2VDDI	V	
Input Leakage Current	IIL	IOH = - 1.0mA	-0.1		+0.1	uA	

#### Notes:

- When evaluating the maximum and minimum of VGH, VDD=2.8V.
- The maximum value of |VGH-VGL| can not over 32.0V.

## 5 Input Terminal Pin Assignment

### 5.1 CN1 Pin Assignment

(Reference Connector: Hirose\_FH12A-10S-0.5SH(55))

Pin No	Symbol	Description	Input/Output	Note
1	GND	Power Ground	P	
2	VCC	Power Supply (Analog)	P	
3	IOVCC	Power Supply (Digital)	P	
4	CS	Chip select input pin.	P	
5	AO	Determines whether the access is related to data or command.	I	
6	RESET	Reset input pin	I	
7	SCL	Serial input clock	I	
8	SDA	Serial input data	I	
9	TE	Tearing effect signal is used to synchronize MCU to frame memory writing.	I	
10	GND	Power Ground	I	

## 6 Optical Characteristics

The following items are measured under stable conditions. The optical characteristics should be measured in a dark room

Measuring equipment: BM-7A

Item		Symbol	Condition	Min.	Typ.	Max.	Unit	Note
White Reflectance (with Polarizer)		Rw (%)	$\Theta=0$ Normal viewing angle	—	44.57	—	%	(4) Measuring with HSD polarizer · Reference Only Base on Vop=4.5V
Contrast Ratio		CR	—	—	15	—	—	(1)(2) Base on Vop=4.5V
Color Chromaticity (CIE1931)	White	W <sub>x</sub>	—	—	(0.300)	—	—	(1)(4) Measuring with HSD polarizer · Reference Only
		W <sub>y</sub>	—	—	(0.330)	—	—	
Viewing Angle	Hor.	$\Theta_L$	CR>2	—	60	—	—	(1)(4) Measuring with HSD polarizer · Reference Only
		$\Theta_R$		—	60	—		
	Ver.	$\Theta_U$		—	60	—		
		$\Theta_D$		—	60	—		



Note (1) Definition of Viewing Angle:

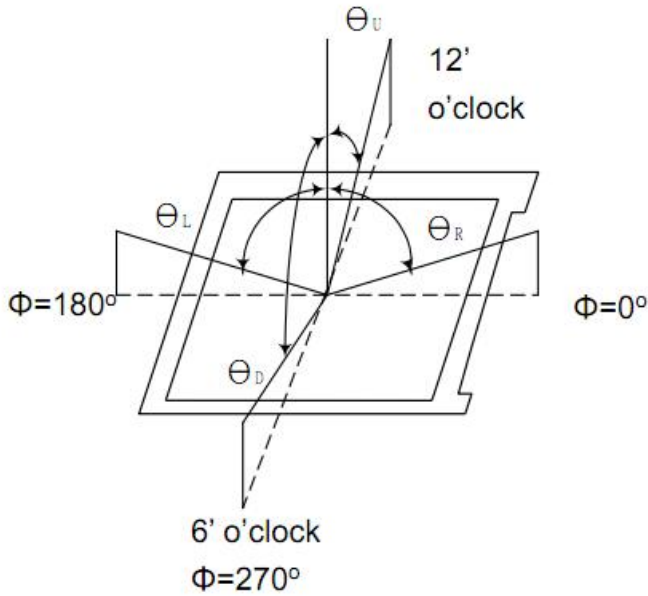

Note (2) Definition of Contrast Ratio (CR) :  
measured at the center point of panel

$$CR = \frac{\text{Luminance with all pixels white}}{\text{Luminance with all pixels black}}$$

Note (3) Definition of Response Time : Sum of  $T_R$  and  $T_F$

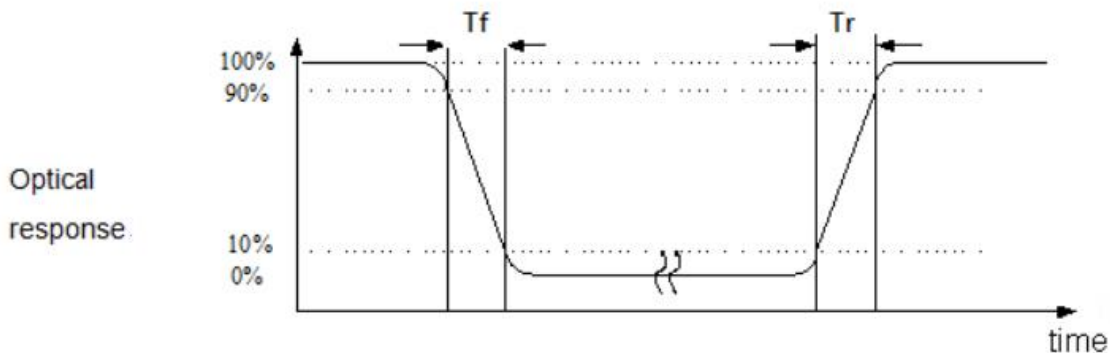

Note (4) Definition of optical measurement setup

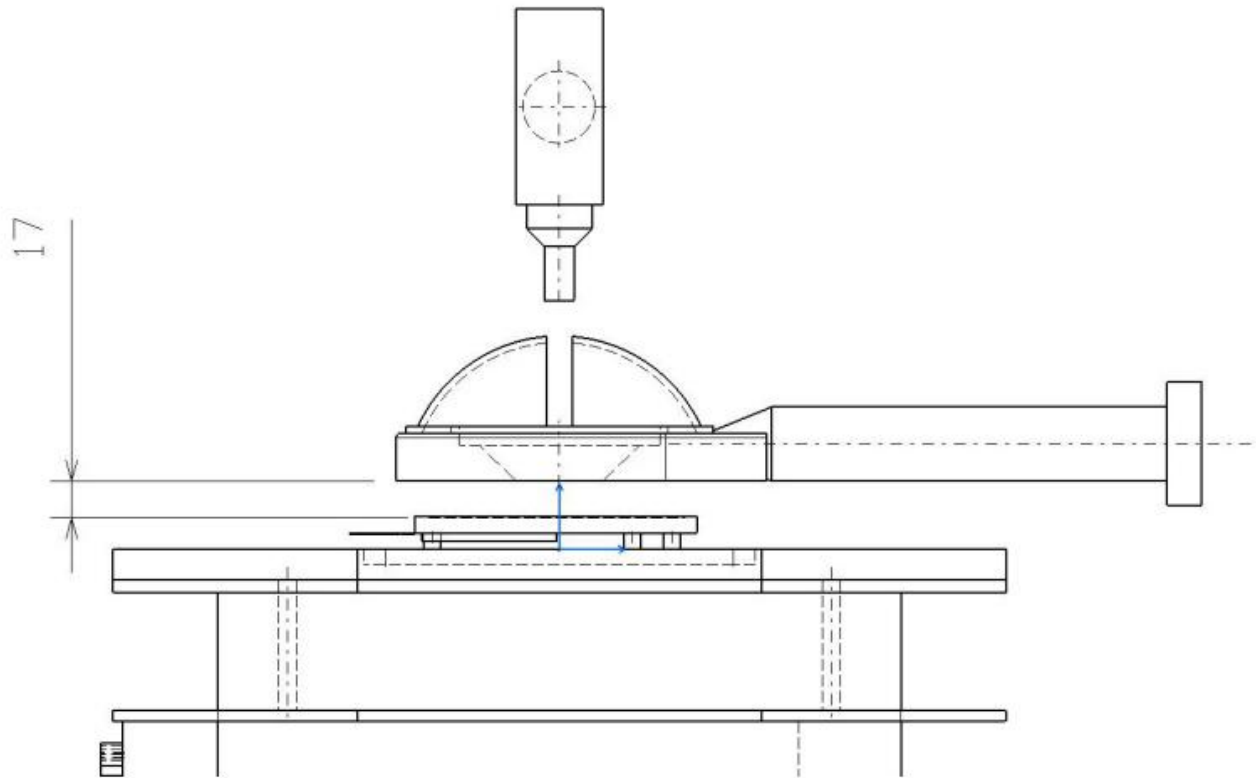

## 7 AC Characteristics

### 7.1 Interface Timing

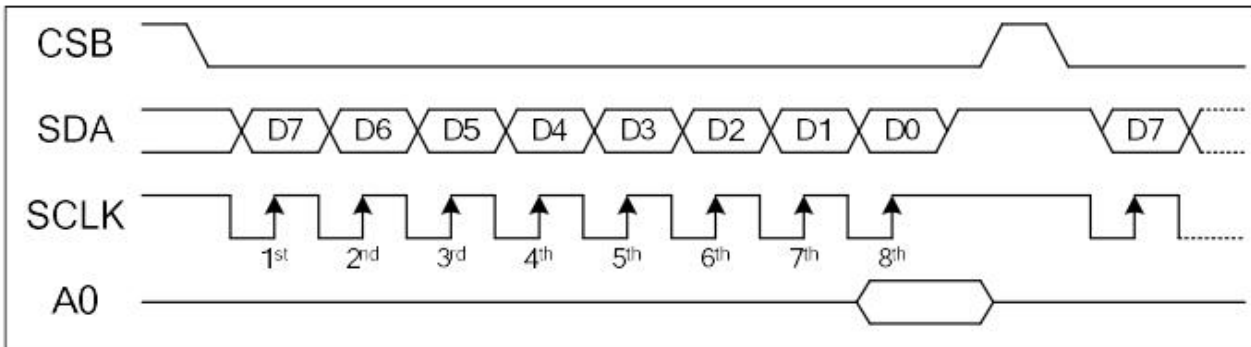

**Write Operation of 4-Line SPI**

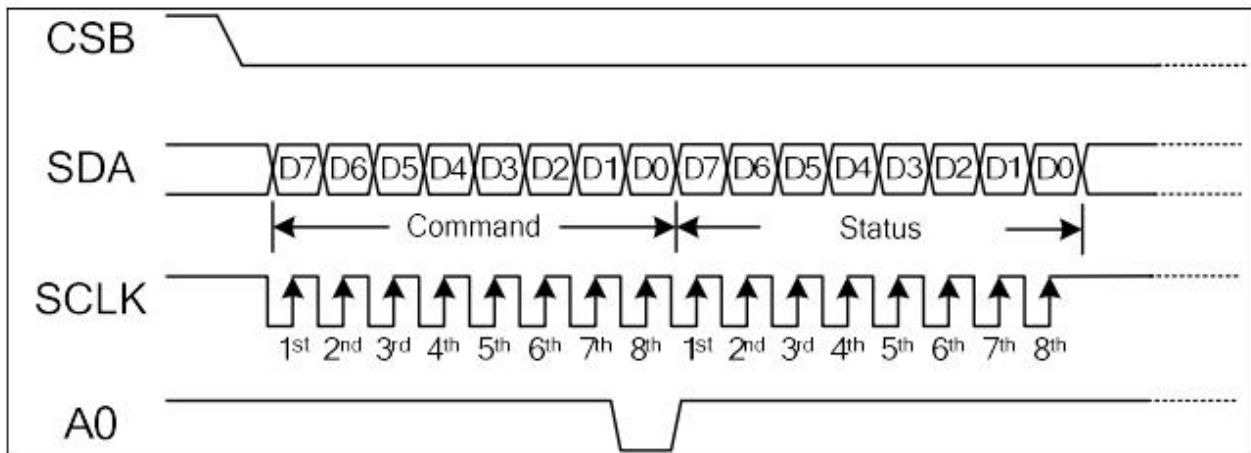

**Read Status Operation of 4-Line SPI**

## 7.2 Power ON/OFF sequence

VDDI and VDDA can be applied in any order.

VDDA and VDDI can be power down in any order.

During power off, if LCD is in the Sleep Out mode, VDDA and VDDI must be powered down minimum 120msec after RSTB has been released.

During power off, if LCD is in the Sleep In mode, VDDI or VDDA can be powered down minimum 0msec after RSTB has been released.

CSB can be applied at any timing or can be permanently grounded. RSTB has priority over CSB.

*Note 1: There will be no damage to the display module if the power sequences are not met.*

*Note 2: There will be no abnormal visible effects on the display panel during the Power On/Off Sequences.*

*Note 3: There will be no abnormal visible effects on the display between end of Power On Sequence and before receiving Sleep Out command. Also between receiving Sleep In command and Power Off Sequence.*

*Note 4: If RSTB line is not held stable by host during Power On Sequence as defined in the sequence below, then it will be necessary to apply a Hardware Reset (RSTB) after Host Power On Sequence is complete to ensure correct operation. Otherwise function is not guaranteed.*

The power on/off sequence is illustrated below

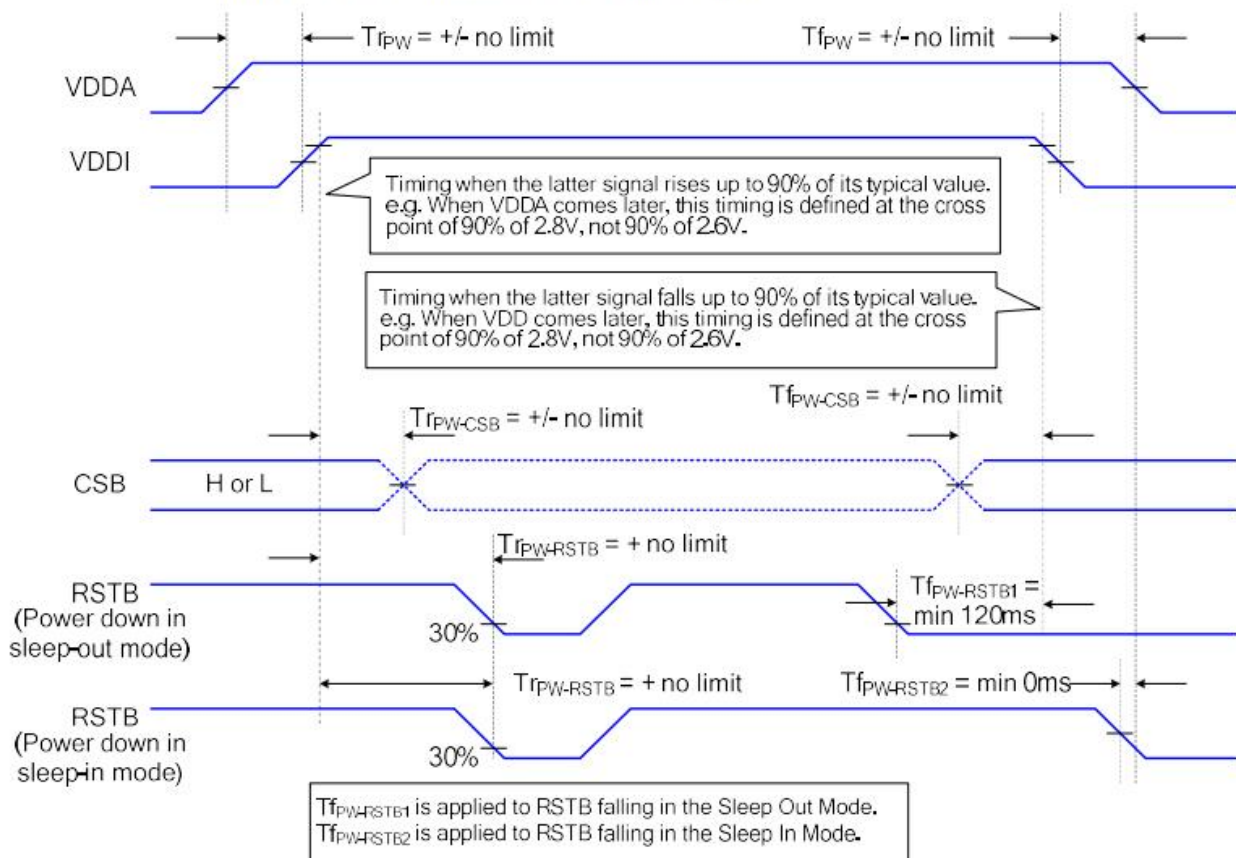

## 8 Test

No change on display and in operation under the following test condition.

Condition: Unless otherwise specified, tests will be conducted under the following condition.

Temperature:  $20 \pm 5^\circ\text{C}$ .

Humidity:  $65 \pm 5\% \text{RH}$ .

Tests will be not conducted under functioning state.

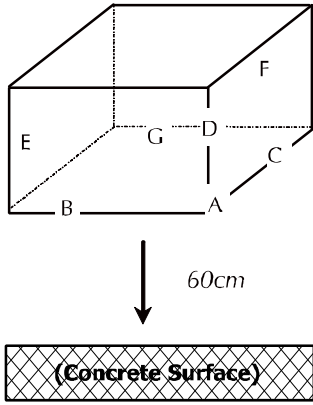
No.	Parameter	Condition	Notes
1	High Temperature Operating	$70^\circ\text{C} \pm 2^\circ\text{C}$ , 240hrs (Operation state).	
2	Low Temperature Operating	$-20^\circ\text{C} \pm 2^\circ\text{C}$ , 240hrs (Operation state).	1
3	High Temperature Storage	$80^\circ\text{C} \pm 2^\circ\text{C}$ , 240hrs.	2
4	Low Temperature Storage	$-30^\circ\text{C} \pm 2^\circ\text{C}$ , 240hrs.	1,2
5	High Temperature and High Humidity Operation Test	$60^\circ\text{C} \pm 2^\circ\text{C}$ , 90%, 240hrs	1,2
6	Vibration Test	Total fixed amplitude: 1.5mm. Vibration Frequency: 10–55Hz. One cycle 60 seconds to 3 direction of X, Y, Z each 15 minutes.	3
7.	Drop Test	<p>To be measured after dropping from 60cm high on the concrete surface in packing state.</p>  <p><i>Dropping method corner dropping:</i></p> <p><i>A corner: Once edge dropping.</i></p> <p><i>B, C, D edge: Once face dropping.</i></p> <p><i>E, F, G face: Once.</i></p>	

## 9 Dimensional outlines

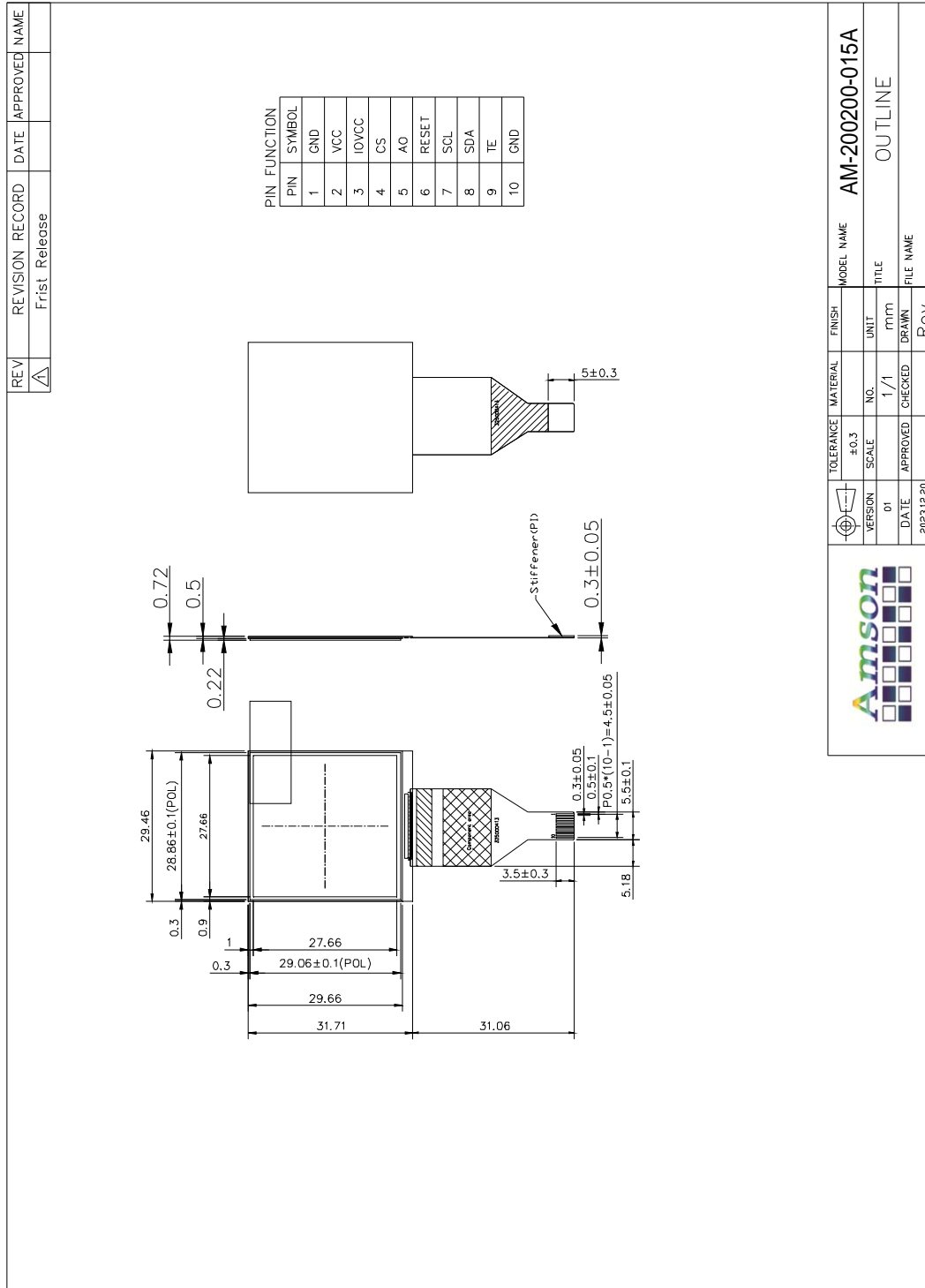

## 10 Incoming Inspection Standards

### 10.1 Inspection and Environment Conditions

#### 10.1.1 Inspection Conditions:

- (1) Inspection Distance: 35 cm±5cm
- (2) View Angle : Light-on Inspection Angle : ±5°

Cosmetic Inspection Angle : ±45°

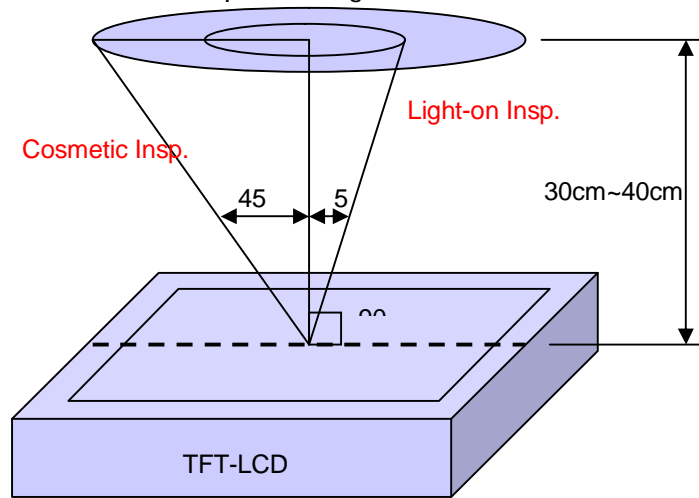

( perpendicular to LCD panel surface)

#### 10.1.2 Environment Conditions:

Ambient Temperature		23°C±5°C
Ambient Humidity		55±10%RH
Ambient Illumination	Cosmetic Inspection	more than 600 Lux
	Functional Inspection	300~500 Lux

#### 10.1.3 Sampling Conditions:

- (1) Lot Size: Quantity of shipment lot per model
- (2) Sampling Method:

Sampling Plan		MIL-STD-105E
		Normal Inspection, Single Sampling
		Level II
AQL	Major Defect	1.0%
	Minor Defect	1.5%

- (3) The classification of Major(MA) and Minor(MI) defects is shown as 3. Inspection Criteria.

## 10.1.4 Inspection Criteria

### 10.1.4.1 Cosmetic Inspection(Panel):

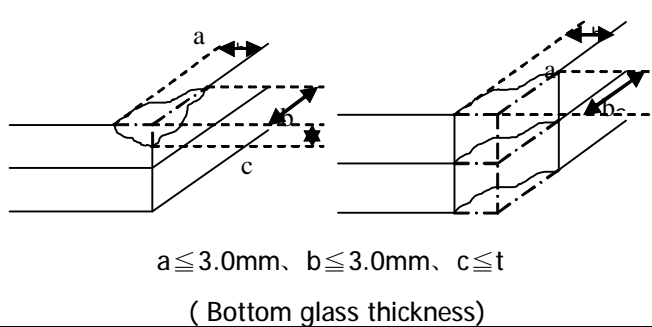
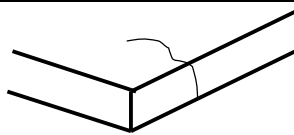
Item	Judgment Criteria	Classification
Chipping on Panel	 <p><math>a \leq 3.0\text{mm}</math>, <math>b \leq 3.0\text{mm}</math>, <math>c \leq t</math> ( Bottom glass thickness)</p>	MA
Scratch on Panel *Note-2	<p><math>W \leq 0.05\text{mm}</math> or <math>L &lt; 5\text{mm}</math>: Ignored  <math>0.05\text{mm} &lt; W \leq 0.1\text{mm}</math> and <math>L \leq 5\text{mm}</math>: <math>N \leq 5</math>  <math>W &gt; 0.1\text{mm}</math> or <math>L &gt; 5\text{mm}</math>: Not allowed</p>	MI
Bubble or Dent on Panel *Note-3	<p><math>D \leq 0.2\text{mm}</math>: Ignored  <math>0.2\text{mm} &lt; D \leq 0.3\text{mm}</math>: <math>N \leq 5</math>  <math>D &gt; 0.3\text{mm}</math>: Not allowed</p>	MI
Panel Crack	 <p>Not Allowed crack</p>	MA
Bezel Deformation	Obvious deformation is not allowed.	MI
Bezel Oxidation	Not allowed if it rusts continuously over 1 cm (It is out of warranty with rusted tin plate)	MI
Bezel Scratch	$L \leq 20\text{mm}$ , $W \leq 0.2$ , $N \leq 3$	MI
Metal Squash Dent /Flange(Front Side)	$D(W) \leq 1, L \leq 3, N \leq 3;$	MI
B/L High Voltage Wire Denudation	Not allowed	MA
Polarizer flaw or leak out resin	Defect is defined as the active area.	MI



Outline Dimension	Must in Spec, refer to related product spec.	MI
-------------------	--	----

10.1.4.2 Functional Inspection:

Item	Judgment Criteria			Classification
	Area(Note1)	I	O	
Point Defect	Bright dot	Random	1	
		2 dots adjacent	0	0
		3 dots adjacent or more	0	0
	Dark dot	Random	2	
		2 dots adjacent	0	
		3 dots adjacent or more	0	0
	Total Dot Defect		3	
	Distance	Distance between Bright and Bright dot	$L \geq 5\text{mm}$	
		Distance between Bright and Dark dot	$L \geq 5\text{mm}$	
		Distance between Dark dot	$L \geq 5\text{mm}$	
(1) It is defined as Point Defect if defect area $> 0.5\text{dot}$ (2) It is ignored if defect area $\leq 0.5\text{dot}$ (3) Weak point defect will be defined as Bright Dot if it can be observed through ND filter 5% ( Full Screen Black Inspection)				
Line Defect	Obvious vertical or horizontal line defect is not allowed.			MA
Mura	Not allowed if it can be observed through ND Filter 5 %			MI
Foreign Material in spot shape *Note-3	$D \leq 0.2\text{mm}$ : Ignored $0.2\text{mm} < D \leq 0.5\text{mm}$ : $N \leq 8$ $D > 0.5\text{mm}$ : Not allowed			MI
Foreign Material in line or spiral shape *Note-4	$W \leq 0.05\text{mm}$ or $L \leq 5\text{mm}$ : Ignored $0.05\text{mm} < W \leq 0.2\text{mm}$ and $L 1.0\text{mm} \leq 5\text{mm}$ : $N \leq 8$ $W > 0.2\text{mm}$ or $L > 5\text{mm}$ : Not allowed			MI
Display Function Abnormal	No Malfunction can be allowed			MA

Note-1 : I/O Area Definition

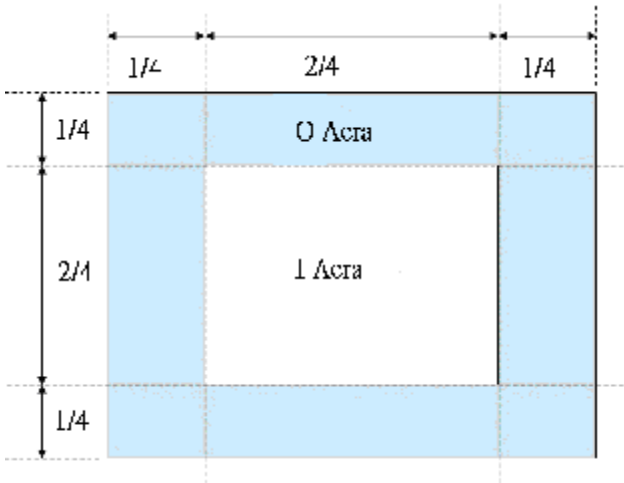

Note-2 : Polarizer Scratch

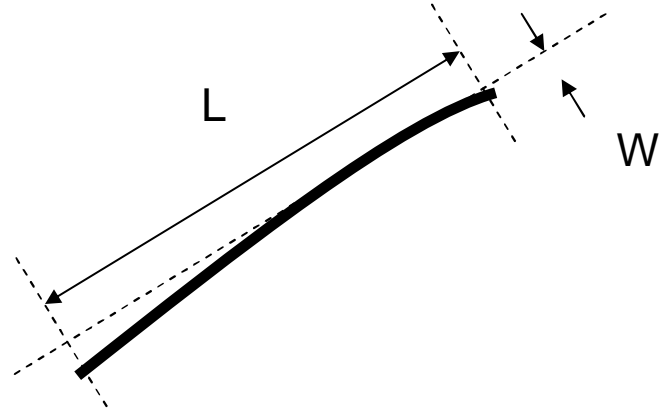

Note-3 : Spot Foreign Material  
( $W \geq L / 4$ )

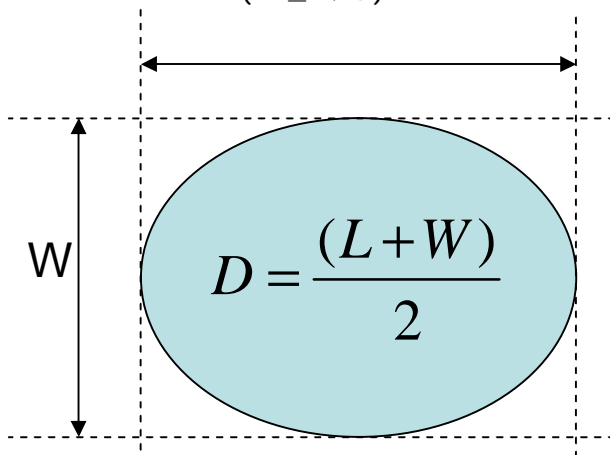

Note-4 : Line or Spiral Foreign Material  
( $W < L / 4$ )

